

Wraptite®

Installation, Detailing & Compliance
for High Rise Applications



An aerial photograph of a solar farm. The solar panels are arranged in neat, parallel rows on a bright red roof. The panels are tilted at an angle. The image is taken from a high angle, looking down at the rows of panels. The red color of the roof is very vibrant and uniform. The solar panels have a blue-tinted glass surface. The metal frames of the panels are visible, and they are supported by a network of steel trusses. The overall scene is clean and organized, showing a large-scale renewable energy installation.

PLEASE NOTE:

The following are instructions for a typical installation of the Wraptite® System: Membrane, Tape, Corners & Liquid Flashing. It is important to review each application and be aware there may be situations that require modifications to these instructions in order to accommodate the unique challenges of your project. Please contact the A. Proctor Group Technical Department for personalised assistance as required (details on reverse).



CONTENTS:

Introduction

- Product Overview
- Required Tools
- Substrate Preparation
- Installation: Best Practice

Installation

- Membrane
- Tape
- Corners
- Windows & Doors
- Wall Penetrations & Large Brackets

Details

- Installation Steps
- Slab Edge
- Column Edge
- Window Head & Sill
- Window Sill at Floor Level
- Soffit
- Parapet
- Balcony

Compliance & Troubleshooting

- Expansion Joints
- Exposed Substrate
- Membrane Creases & Bubbles
- Small Punctures & Tears
- Reverse Shingle
- Peel-back & Delamination
- Incomplete Detailing
- Insufficient Overlaps
- Onsite Damage
- Compromised Adhesive Backing

I. PRODUCT OVERVIEW

WRAPTITE MEMBRANE, TAPE & CORNERS

- Wraptite is an externally applied fully adhered vapour permeable Weather Resistant Barrier/Air Barrier membrane.
- Wraptite consists of a triple layer polypropylene micro-porous film laminate, with a proprietary acrylic vapour permeable adhesive and silicone-coated PET release liner.
- Wraptite bonds easily to multiple substrates. Primer is not required*.
- Wraptite must not be applied in areas where it will be permanently exposed to UV light e.g. behind open-jointed cladding.
- Adhesive curing time = approx. 6hrs depending on environmental conditions.

WRAPTITE LIQUID FLASHING (LF)

- Wraptite Liquid Flashing (LF) is a high-quality, gunable, low-odour, elastomeric, polyether, liquid-applied flashing and detailing membrane.
- Wraptite LF bonds easily to multiple substrates.
- Wraptite LF is compatible with the entire range of A. Proctor Group's vapour permeable products and is ideal for use in complex details. May also be used to protect the leading edge of Wraptite membrane, tape and corners from water ingress if those edges cannot be protected by overlapping in a shingle fashion.
- 1 x 600ml Wraptite LF sausage covers approx. 1.4 - 1.8m². Coverage rates will vary depending on the substrate.
- Product skins within 30 minutes at 21°C (70°F) and 50% relative humidity.
- Wraptite LF is moisture curing. Low temperatures + low relative humidity slows drying time. High temperatures + high relative humidity accelerates drying time.

2. REQUIRED TOOLS

Membrane

- Utility Knife
- Large Rubber Roller
- Small Detailing Roller
- Marker Pen
- Measuring Tape
- Scissors

Liquid Flashing

- Barrel Sealant Gun
- Putty Knife
- Clean Cloth

**In exceptional circumstances, an acrylic primer can be used to aid adhesion to some surfaces such as concrete. Recommendations can be made available on request.*



3. SUBSTRATE PREPARATION

- Substrate condition is critical to the adhesive performance of any self-adhered membrane or liquid-applied flashing.
- Clean any loose dust or dirt from the substrate by wiping with a clean dry cloth or brush. Remove and replace any damaged structural wall components.

WRAPTITE MEMBRANE, TAPE & CORNERS

- Can be applied to various substrates including:
 - > Aluminium (Painted or Mill Finish)
 - > Anodised Aluminium
 - > Concrete Block
 - > Exterior Grade Gypsum / Fibre Board
 - > Galvanised Metal
 - > In-Situ Concrete
 - > OSB
 - > Precast Concrete
 - > Pre-Painted Steel
 - > Rigid Vinyl
 - > Steel
 - > Plywood

PRIMER IS NOT REQUIRED

WRAPTITE LIQUID FLASHING (LF)

- Can be applied to various substrates including:
 - > Aluminium (Painted or Mill Finish)
 - > Concrete
 - > Vinyl
 - > Brick
 - > Wood
 - > Exterior Sheathing Boards

4. INSTALLATION: BEST PRACTICE

WRAPTITE MEMBRANE, TAPE & CORNERS

- Building design requirements should be considered prior to application of Wraptite to minimise waste. Penetrations/openings will need to be correctly detailed to ensure a weather and air tight installation.
- Keep Wraptite in the original packaging which also functions as a dispenser.
- Wraptite is easily cut to desired lengths and can be installed in either a vertical or horizontal orientation. Use a hand roller as illustrated to ensure a continuous and effective bond with the substrate.
- **IMPORTANT:** Failure to roller the membrane effectively may result in poor adhesion to the substrate. Poor adhesion may result in air pockets (bubbles) appearing, especially when Wraptite is facing into direct sunlight. To remedy this, roller over the bubbles ensuring a proper bond to the substrate is achieved.
- Always install with an overlap, with the upper courses lapped over lower courses. Wraptite installed around penetrations such as windows and doors must be installed in the correct sequence to ensure an overlapping “shingled” result.
- All horizontal and vertical overlaps must be a minimum of 75mm. Vertical overlaps should be staggered from floor-to-floor or separated by a horizontally applied Wraptite strip. Internal and external vertical corners should have a minimum overlap of 150mm.
- At the end of each working day, protect the leading edge of Wraptite with a temporary tarpaulin to ensure liquid water does not seep behind the membrane.
- Wraptite should only be applied in dry weather when air and surface temperatures are above -10°C. Do not install Wraptite in adverse weather conditions.
- Wraptite should be covered with external cladding within 120 days during construction. If exceeding this limit is unavoidable, protect Wraptite from the elements with a tarpaulin.
- All walling and roofing membranes require protection from heavy/prolonged rainfall and extreme weather events while being installed. Waterproofing materials (e.g. tarpaulins) should be utilised as necessary to ensure the leading edges of all membranes and interior spaces are protected until the primary cladding and roofing is in place.

WRAPTITE LIQUID FLASHING

- Wraptite Liquid Flashing is not for use in place of Wraptite Membrane, as a structural sealant, or in locations below ground or that will be continuously in contact with water.



5. MEMBRANE

HORIZONTAL (two-person method)

1. Snap chalkline for guidance.
2. Pre-cut material to required length.
3. Roll cut length with release paper outwards.
4. Starting at corner, peel back release paper by approx 150mm (Fig. 01).
5. Fold release paper back and, using hand roller, lightly apply the exposed glue surface to the prepared substrate.
6. Starting in the middle, use hand roller to smooth out any air bubbles, releasing the air to each side (Figs. 03 & 04).

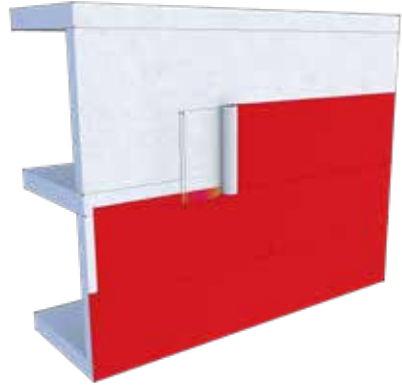

Fig.01: Horizontal installation

VERTICAL (one-person method)

Follow steps 1-5 of Horizontal method, then:

6. Allow rest of rolled up material to drop down with release paper still attached. Check for proper alignment (Fig. 02).
7. When aligned, use hand roller across the entire adhered section.
8. Drop roll down, pulling off release paper.
9. Smooth out air bubbles with a roller (Figs. 03 & 04).
10. Proceed with next row, ensuring minimum 75mm overlap, always in a shingled fashion.



Fig.02: Vertical installation



Fig.03: 'Bubbles' caused by insufficient pressure when installing Wraptite.

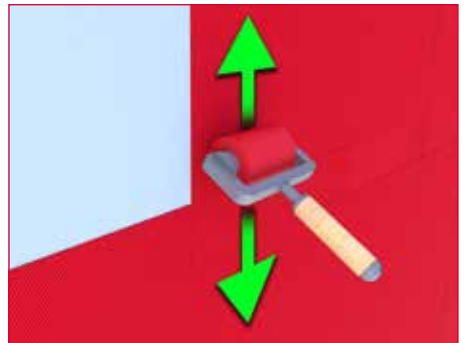

Fig.04: Use roller to release air bubbles and ensure membrane is well adhered.

6. TAPE

1. Make sure surfaces are clean and dry prior to installing the tape.
2. Tape should be cut to length before removing the release liner. Sharp scissors are the best option for this to ensure a clean cut.
3. Try not to handle the adhesive side where possible, i.e. remove liner as tape is being installed directly onto substrate. Hands should also be clean and free from dust/dirt etc.
4. Tape should be well rolled onto substrate with particular attention to the sealing of the outer edges to ensure airtightness and adhesion.
5. A Split-Liner option of Wraptite Tape is available for making airtight seals in challenging areas, for example, when connecting modular assemblies.

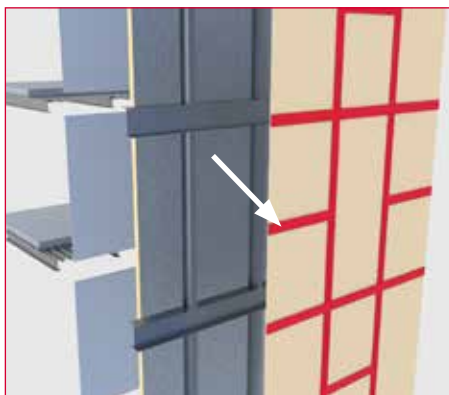

Fig.05: Wraptite Tape used to seal gaps between external sheathing boards.

7. CORNERS

1. Make sure surfaces are clean and dry prior to installing the corners.
2. Try not to handle the adhesive side where possible, i.e. remove liner as corners are being installed directly onto substrate. Hands should also be clean and free from dust/dirt etc.
3. Corners should be well rolled onto substrate with particular attention to the sealing of the outer edges to ensure airtightness and adhesion (Fig. 06).



Fig.06: Use roller to ensure proper adhesion of Wraptite Corners to substrate.

8a. WINDOWS & DOORS USING WRAPTITE CORNERS

1. Pre-fill any joints, gaps and cracks >6mm with a generous bead of Wraptite LF and allow to cure fully if required.
2. Install Corners before Wraptite Membrane reaches the edge of the opening. Use a roller to ensure Corners are well-adhered to the substrate (Fig. 07).
3. Install the next sheet of Membrane so that it covers the Wraptite Corners and the edge of the opening (Fig. 08).

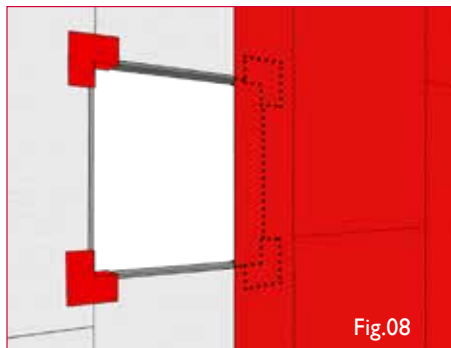
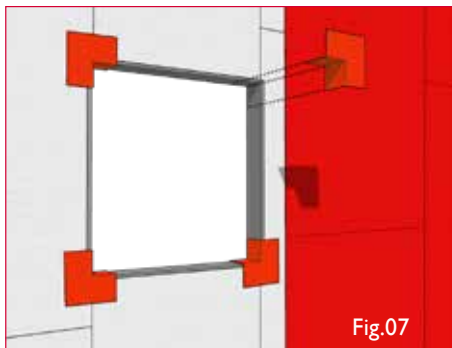

4. Use a box cutter to cut the Membrane in the corners at a 45 degree angle and fold inwards (Figs. 09 & 10). Wraptite Corner edges that bridge the opening (A) must be completely sealed by the Membrane. Wraptite Corner and Membrane edges along the interior side of the wall (B) remain uncovered. Use a roller to ensure Membrane and Corners are well-adhered.

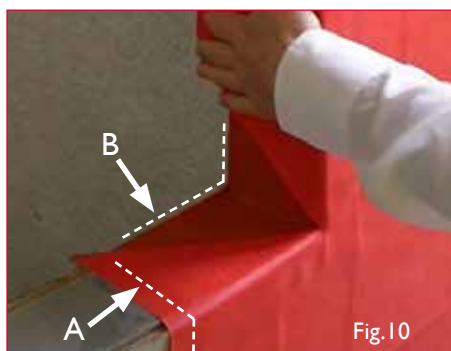
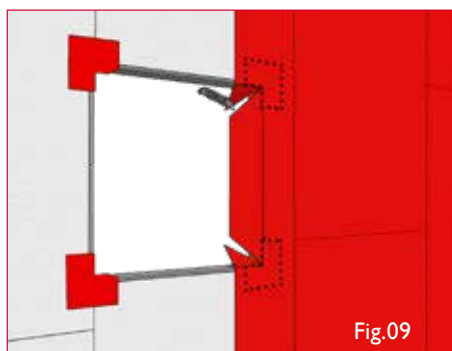

8b. WINDOWS & DOORS USING MEMBRANE ONLY

1. Pre-fill any joints, gaps and cracks >6mm with a generous bead of Wraptite LF and allow to cure fully if required.
2. Overlap the edge of the opening with Wraptite Membrane (Fig. 08).
3. Use a box cutter to cut the Membrane in the corners at a 45 degree angle and fold inwards (Figs. 11 & 12). Use a roller to ensure Membrane is well-adhered to substrate.

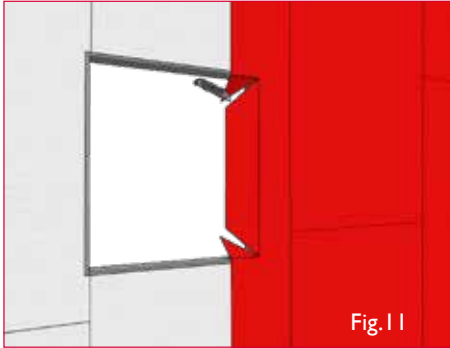

4. Use a length of Wraptite Tape long and wide enough to seal the corner opening and the folded edges of the Membrane (Figs. 13 & 14). The folded Membrane edges (C) must be completely sealed by the Tape. Wraptite Tape and Membrane edges along the interior side of the wall (D) remain uncovered. Use a roller to ensure Membrane and Tape are well-adhered.

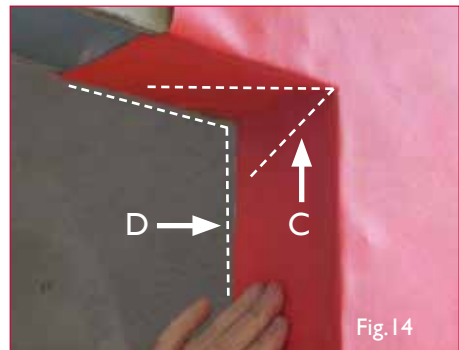
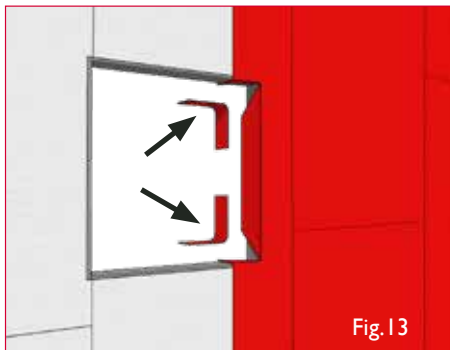

9.a USING EPDM: WRAPTITE UNDER EPDM

1. Follow instructions in Section 8 for installing Wraptite at window and door openings, with or without the use of Wraptite Corners.
2. Install Wraptite Membrane, with or without corners, and well-roller for adhesion. Apply EPDM around perimeter and wrap into the openings following the manufacturer's recommendations (Figs. 15, 16 & 17).

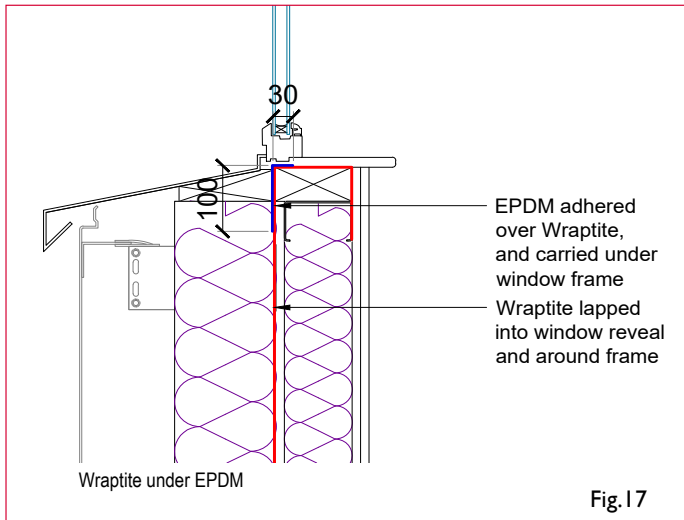
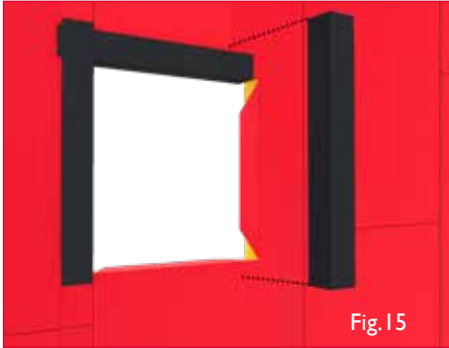

9.b USING EPDM: WRAPTITE OVER EPDM

1. Apply EPDM around perimeter and into window and door openings following the manufacturer's recommendations before Wraptite Membrane reaches the opening's threshold (Fig. 18).
2. Lap Wraptite Membrane over the EPDM up to the opening edges. Seal any exposed horizontal Wraptite edges that are not protected by the shingled effect as described in Section 5 with a bead of Wraptite Liquid Flashing (Figs. 19 & 20).

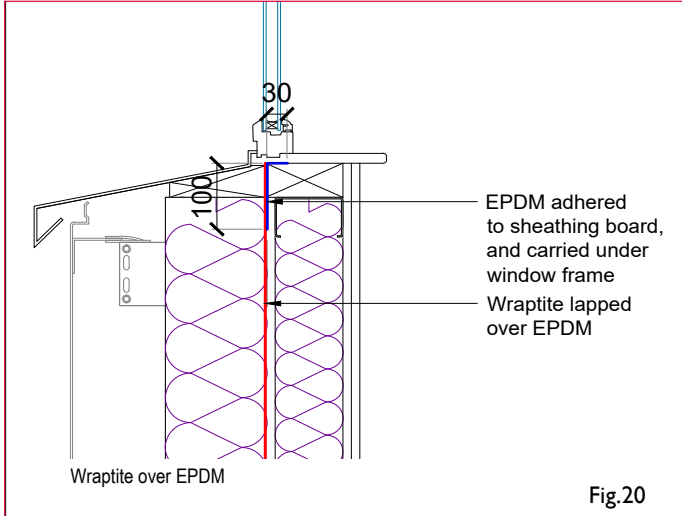
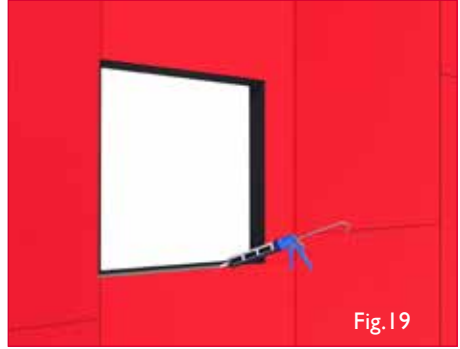
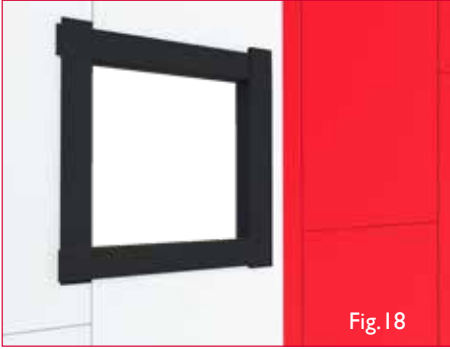

10. PENETRATIONS & LARGE BRACKETS

1. Pre-fill any joints, gaps and cracks wider than 6mm with a generous bead of Wraptite Liquid Flashing (LF) and allow to cure fully.
2. Fill remaining joints, gaps and cracks less than 6mm with Wraptite LF and smooth across the rough surface with a putty knife (Figs. 21 & 22).



Fig.21



Fig.22

3. Install Wraptite Membrane according to guidelines and cut the membrane as close to the edges of the wall penetration as possible. Wraptite Tape may be used to seal areas around the penetration not covered by the Membrane.
4. Apply a thick bead of Wraptite LF around the rough opening, applying it both to the structural wall and the base of the wall penetration (Figs. 23 & 24).
5. Also apply Wraptite LF to any edges of Wraptite Membrane or Tape with a reverse shingle effect (See 'Compliance & Troubleshooting').



Fig.23



Fig.24

- Smooth Wraptite LF with a putty knife around the rough opening evenly. Ensure the spread width is 100-150mm and makes contact with both the structural wall, wall penetration, and Wraptite membrane (Figs. 25 & 26).
- Ensure the Wraptite LF layer is even and covers the entire rough opening with no pinholes, voids or damage.

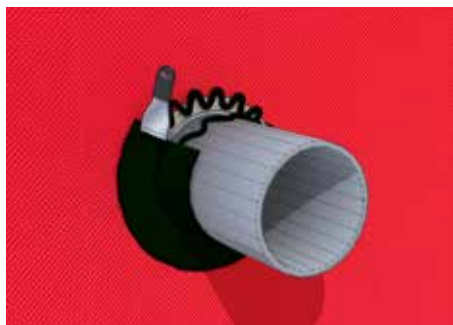

Fig.25



Fig.26

- For large brackets that have been installed over Wraptite Membrane, repeat Steps 4-7 (Figs. 27 & 28).



Fig.27



Fig.28

11. DETAIL: INSTALLATION

Structural frame



Sheathing Board



Align Wraptite, and peel 300mm of release paper



Unroll Wraptite across the surface, removing the release paper in the process. Use firm hand pressure to smooth the Wraptite, ensuring adhesion to the surface

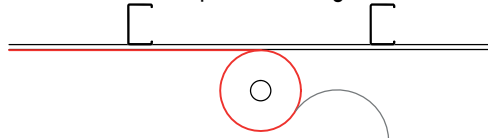

Use a Rubber roller across the Wraptite to remove any irregularities and consolidate joints and details

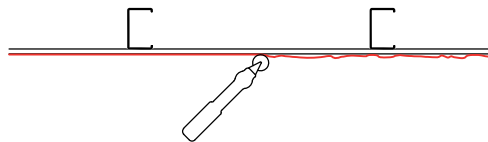

The wall is now airtight and provides defence against water ingress, so the internal lining and insulation can now be installed.

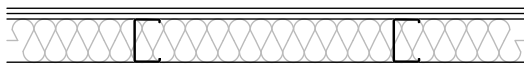

Helping Hand Brackets should be fixed over the Wraptite, with no requirement for further sealing around the fixings.

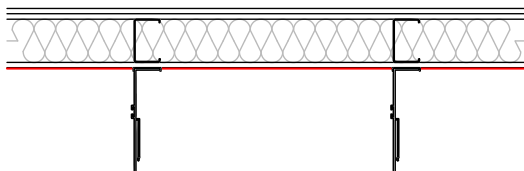

External insulation can be applied over the Wraptite

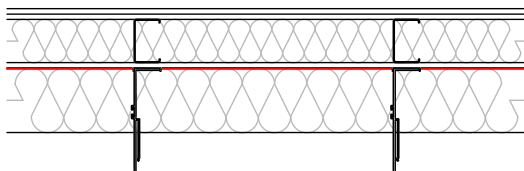

Cladding rails or cavity ties can then be installed following normal procedure

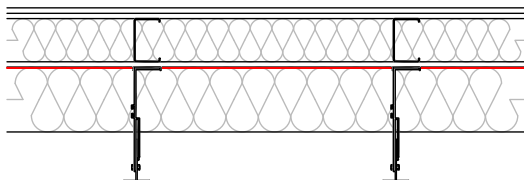

The primary watershedding should be installed within 120 days

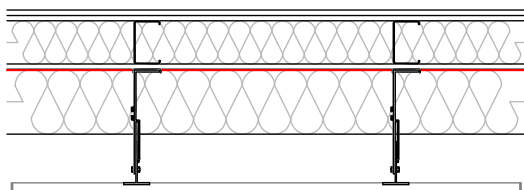

12. DETAIL: SLAB EDGE

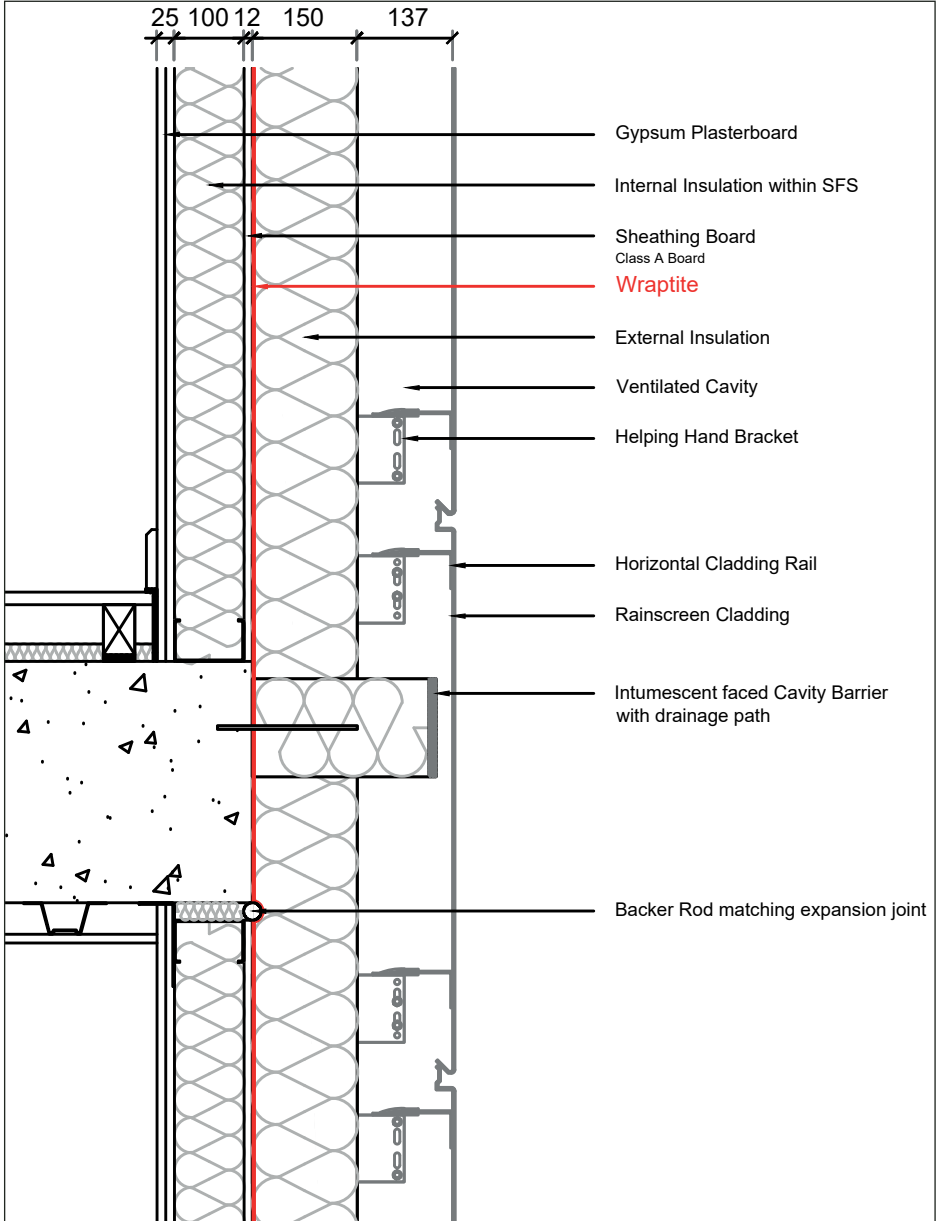

SLAB EDGE - HORIZONTAL RAINSCREEN RAILS

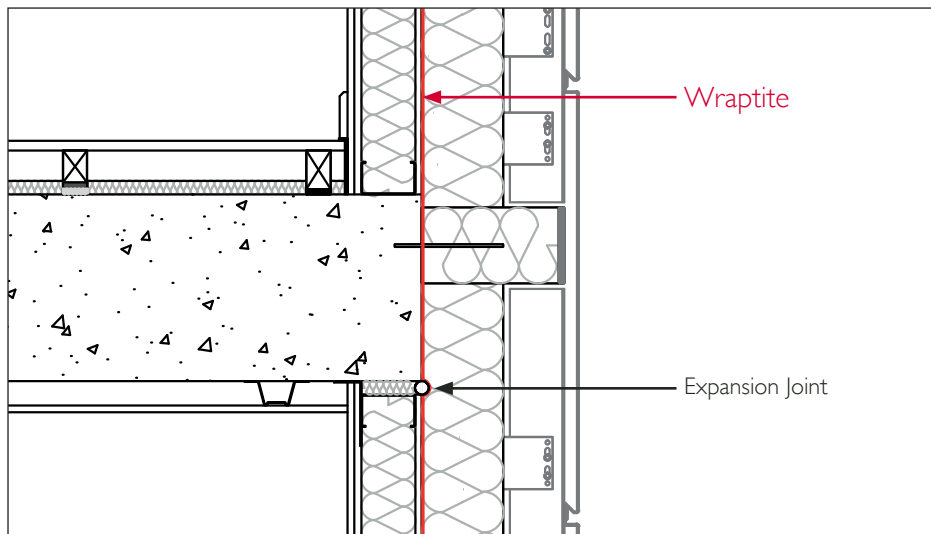

SLAB EDGE - VERTICAL RAINSCREEN RAILS

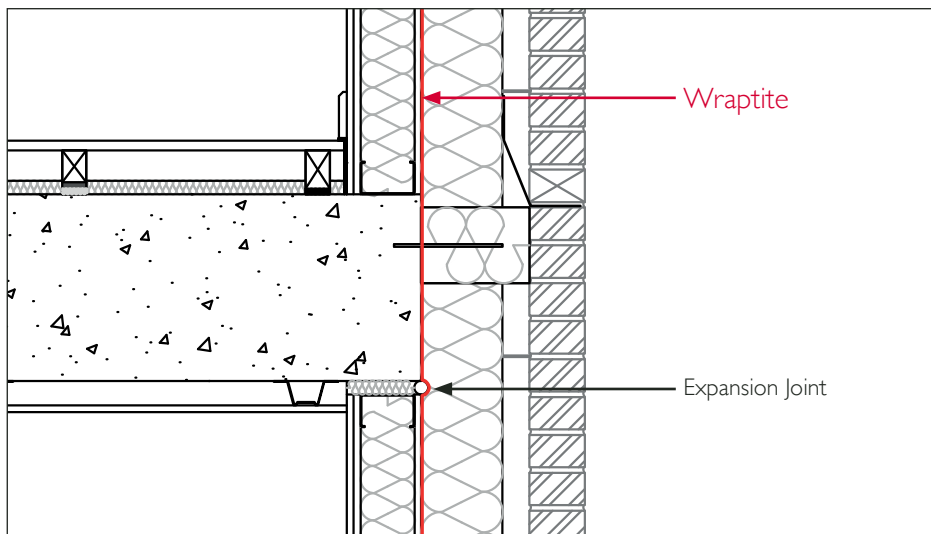

SLAB EDGE - BRICK FAÇADE

13. DETAIL: COLUMN EDGE

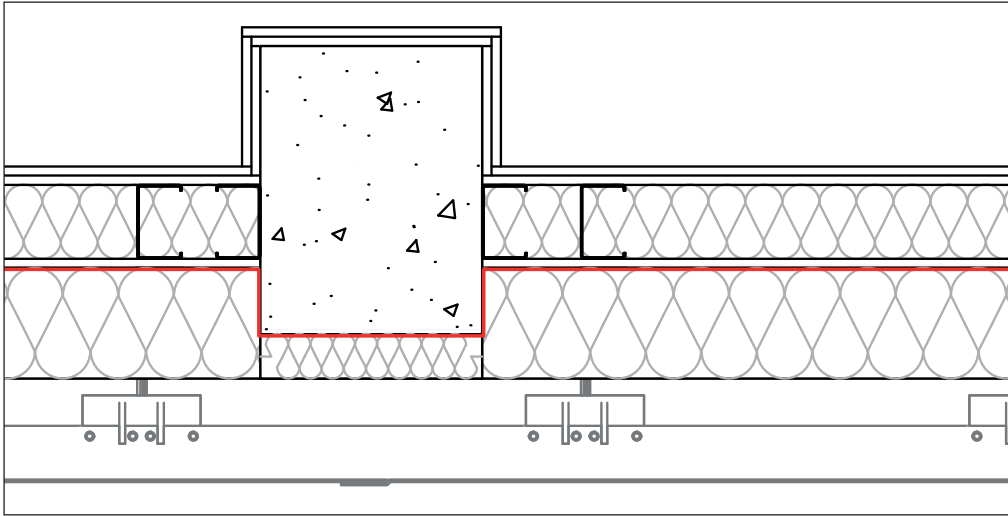

COLUMN - THROUGH SHEATHING BOARD
RAINSCREEN CLADDING

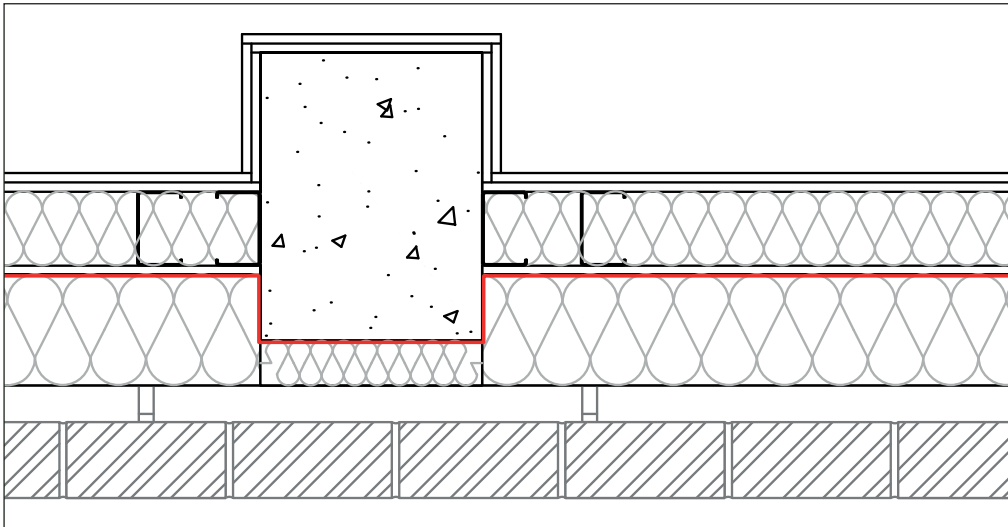

COLUMN - THROUGH SHEATHING BOARD
BRICK FAÇADE

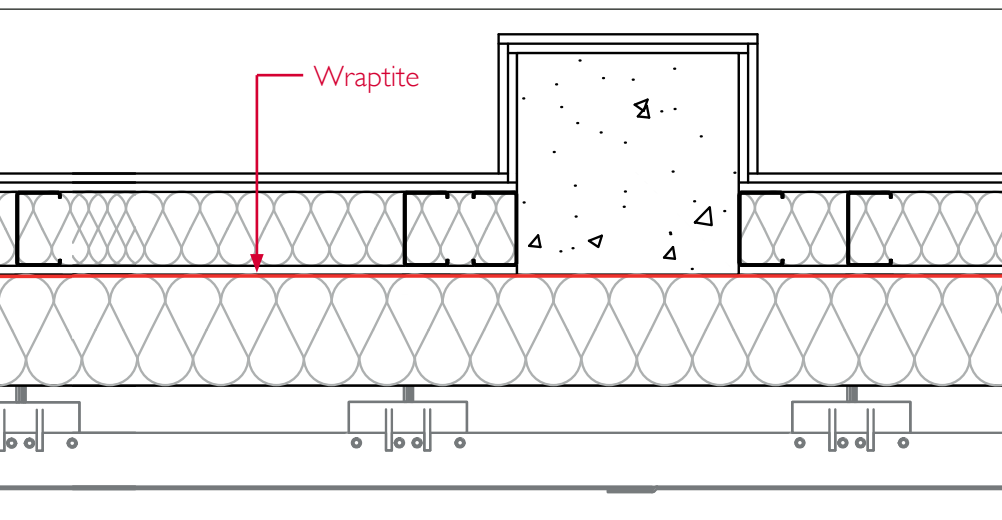

COLUMN - FLUSH WITH SHEATHING BOARD
RAINSCREEN CLADDING

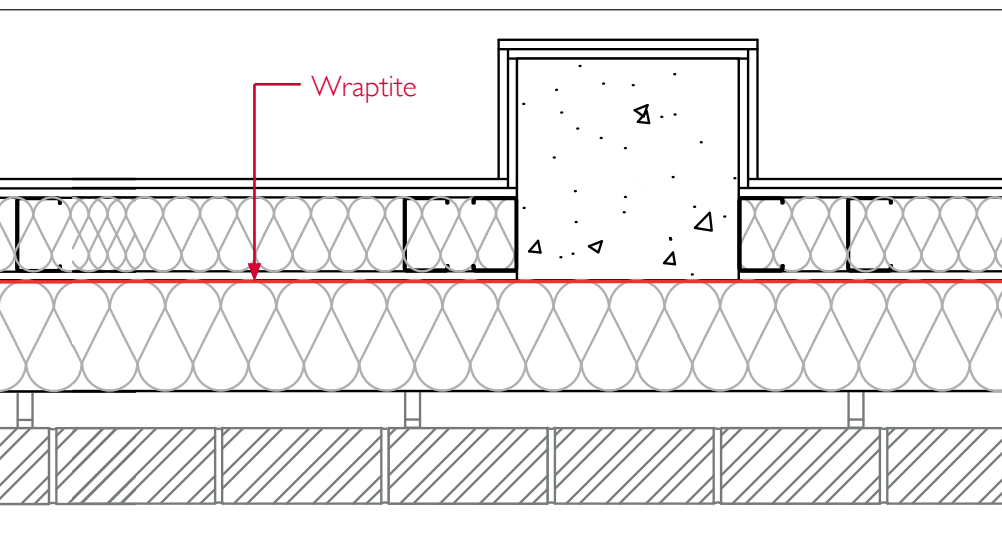

COLUMN - FLUSH WITH SHEATHING BOARD
BRICK FAÇADE

14.a DETAIL: WINDOW HEAD & SILL

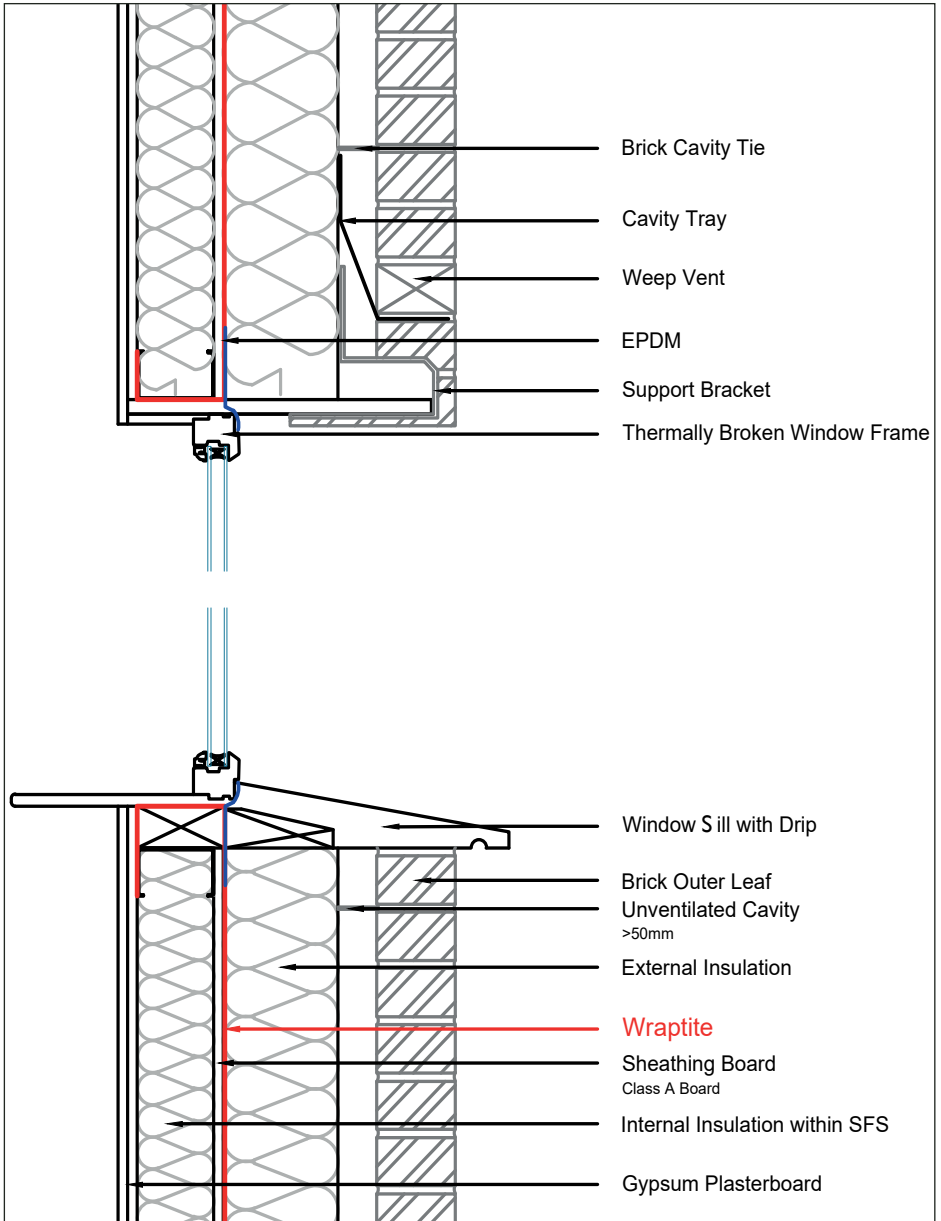

WINDOW HEAD & SILL - BRICK FAÇADE

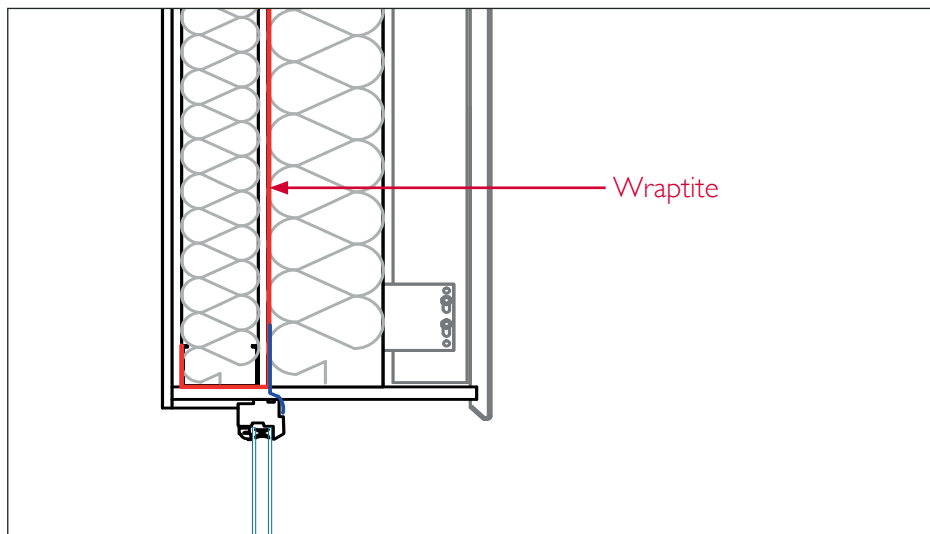

WINDOW HEAD - VERTICAL RAINSCREEN RAILS

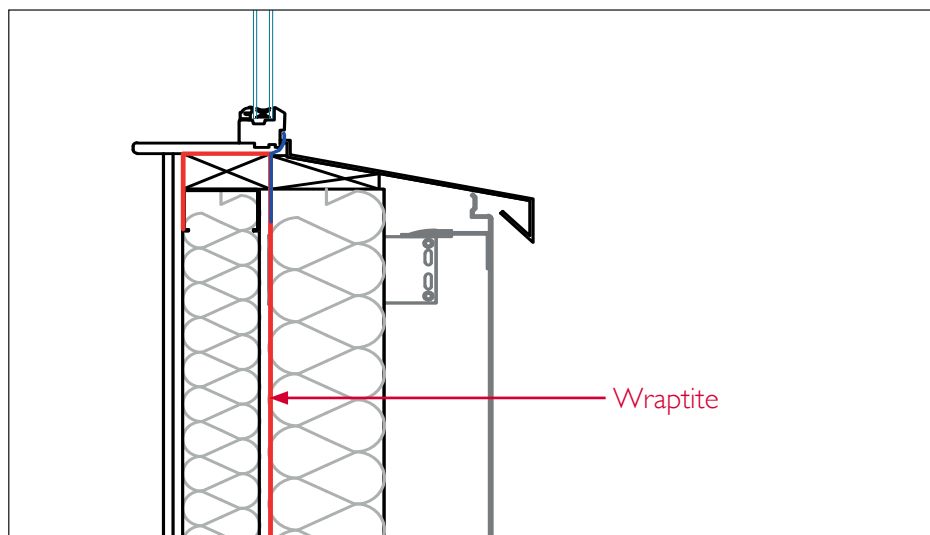

WINDOW SILL - HORIZONTAL RAINSCREEN RAILS

14.b DETAIL: WINDOW SILL AT FLOOR LEVEL

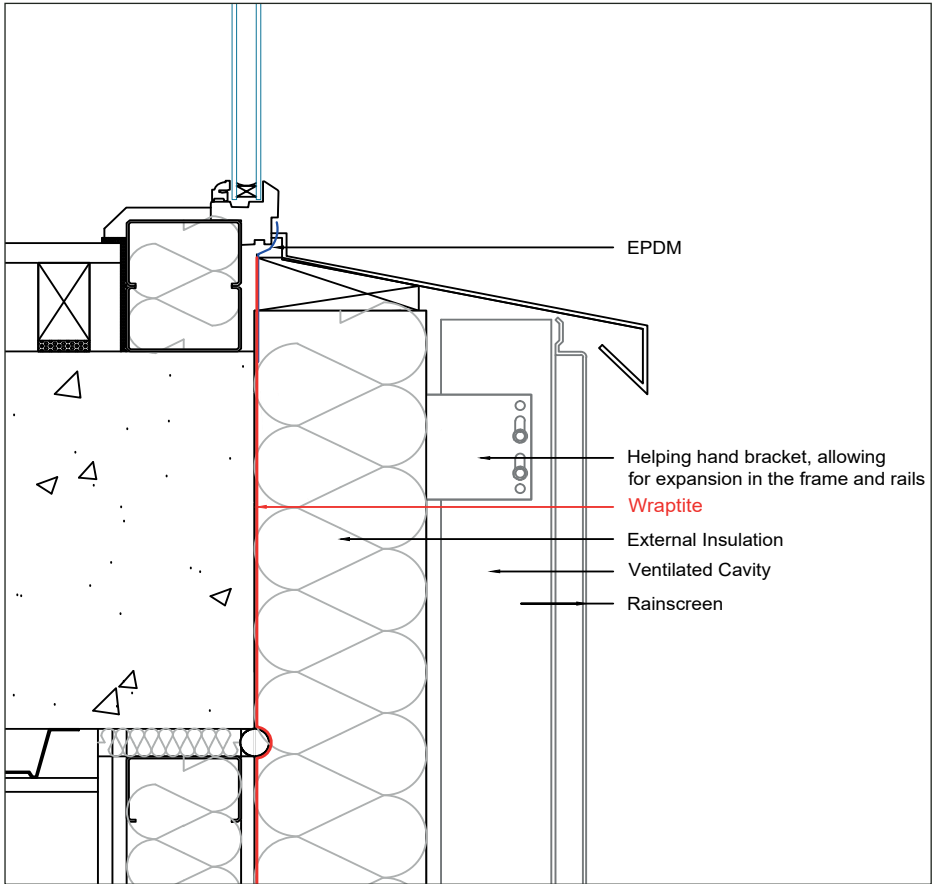

WINDOW SILL AT FLOOR LEVEL
W. RAINSCREEN

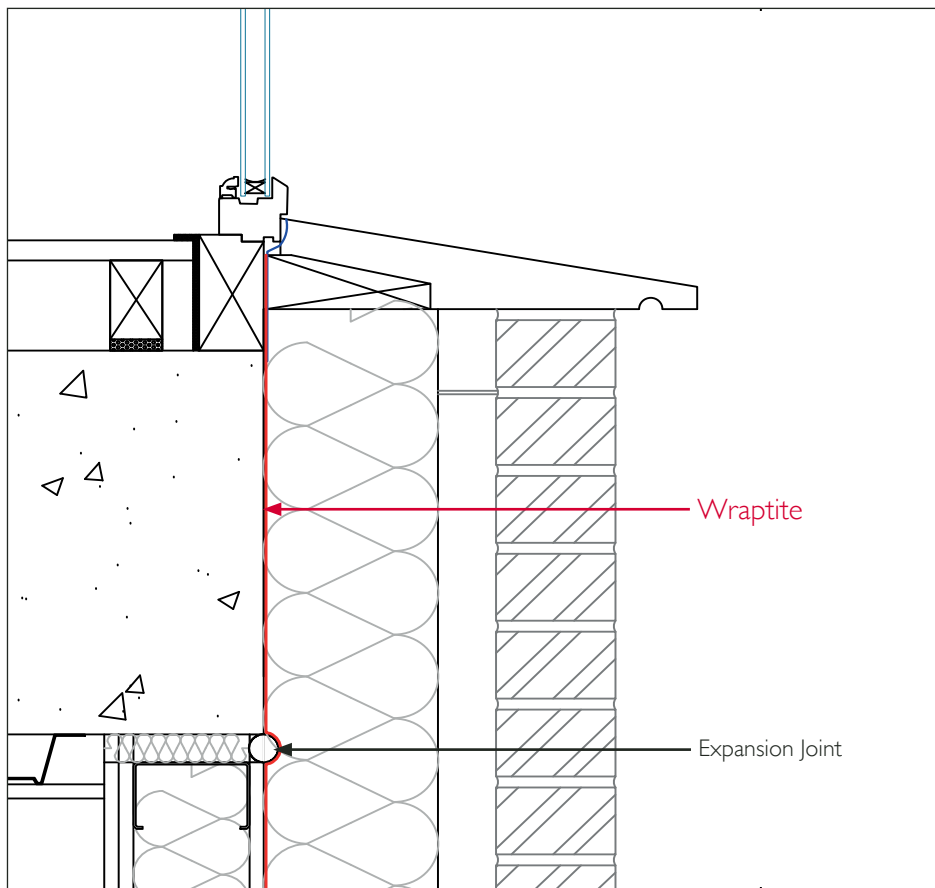

WINDOW SILL AT FLOOR LEVEL
W. BRICK FAÇADE

15. DETAIL: SOFFIT

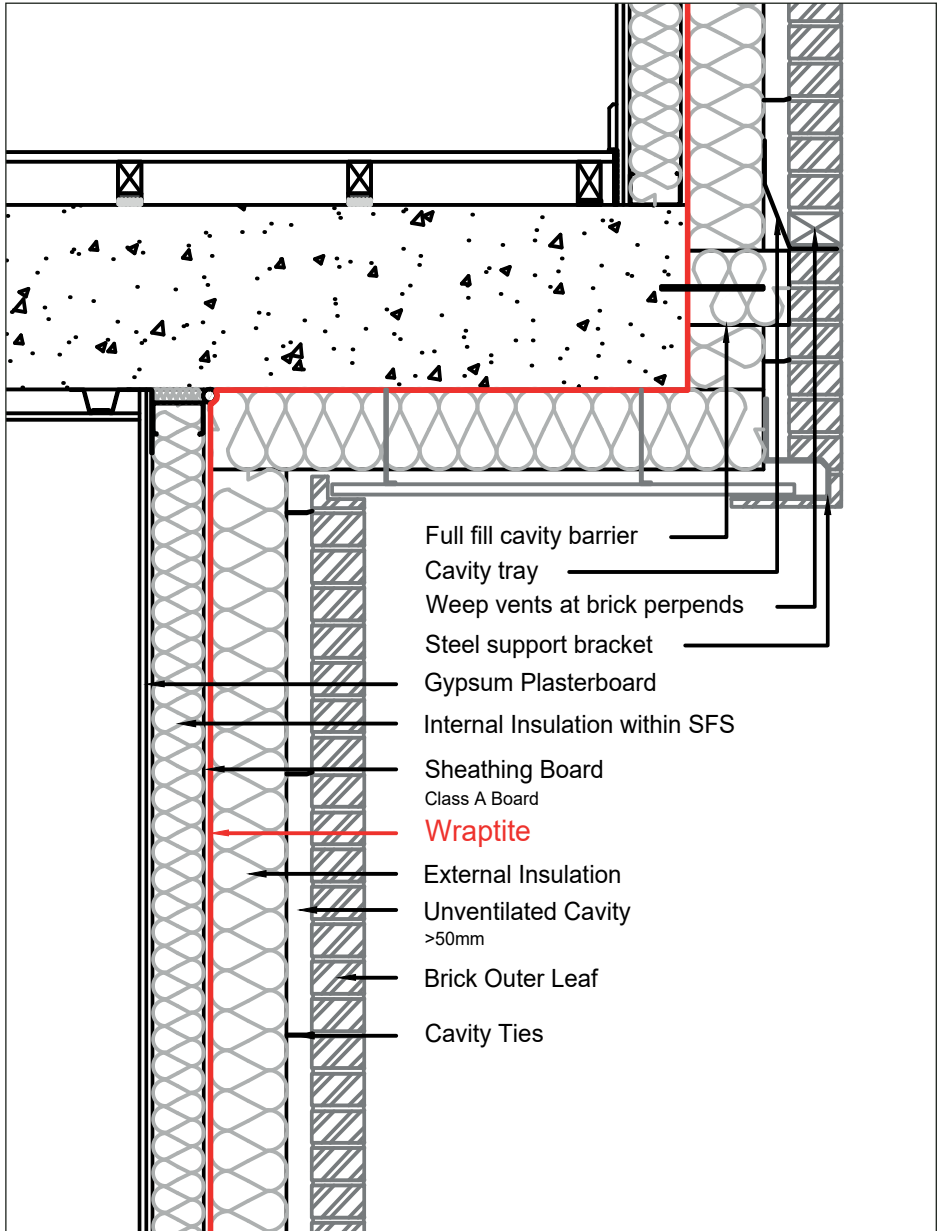

SOFFIT W. BRICK FAÇADE

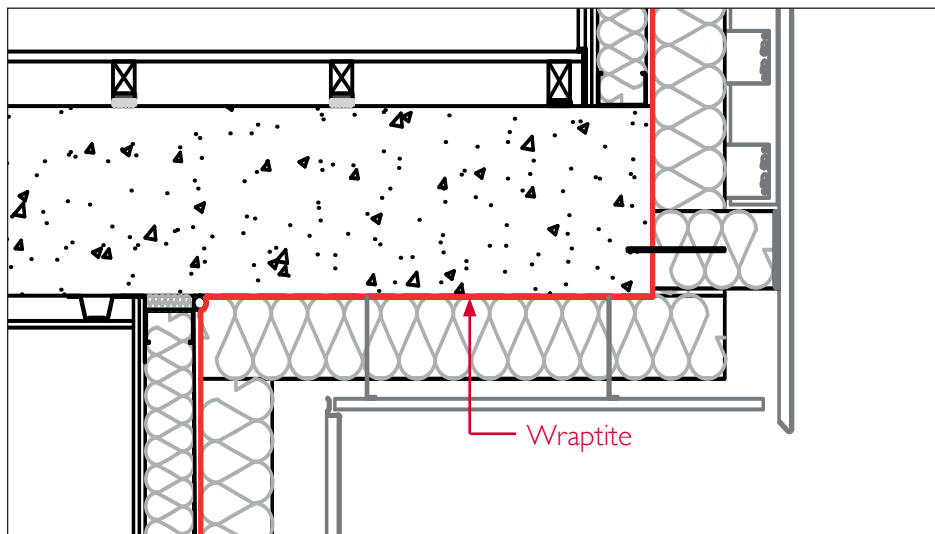

SOFFIT W. VERTICAL RAINSCREEN RAILS

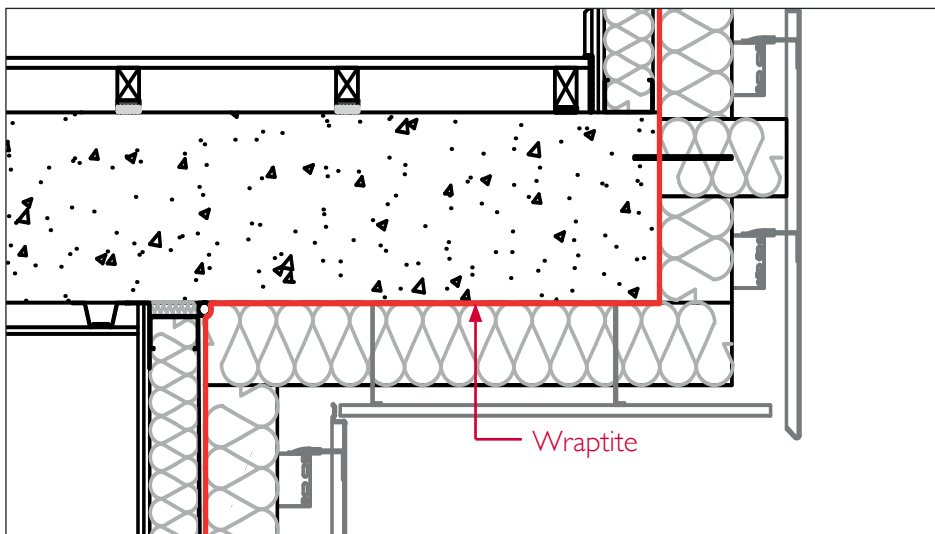

SOFFIT W. HORIZONTAL RAINSCREEN RAILS

16. DETAIL: PARAPET

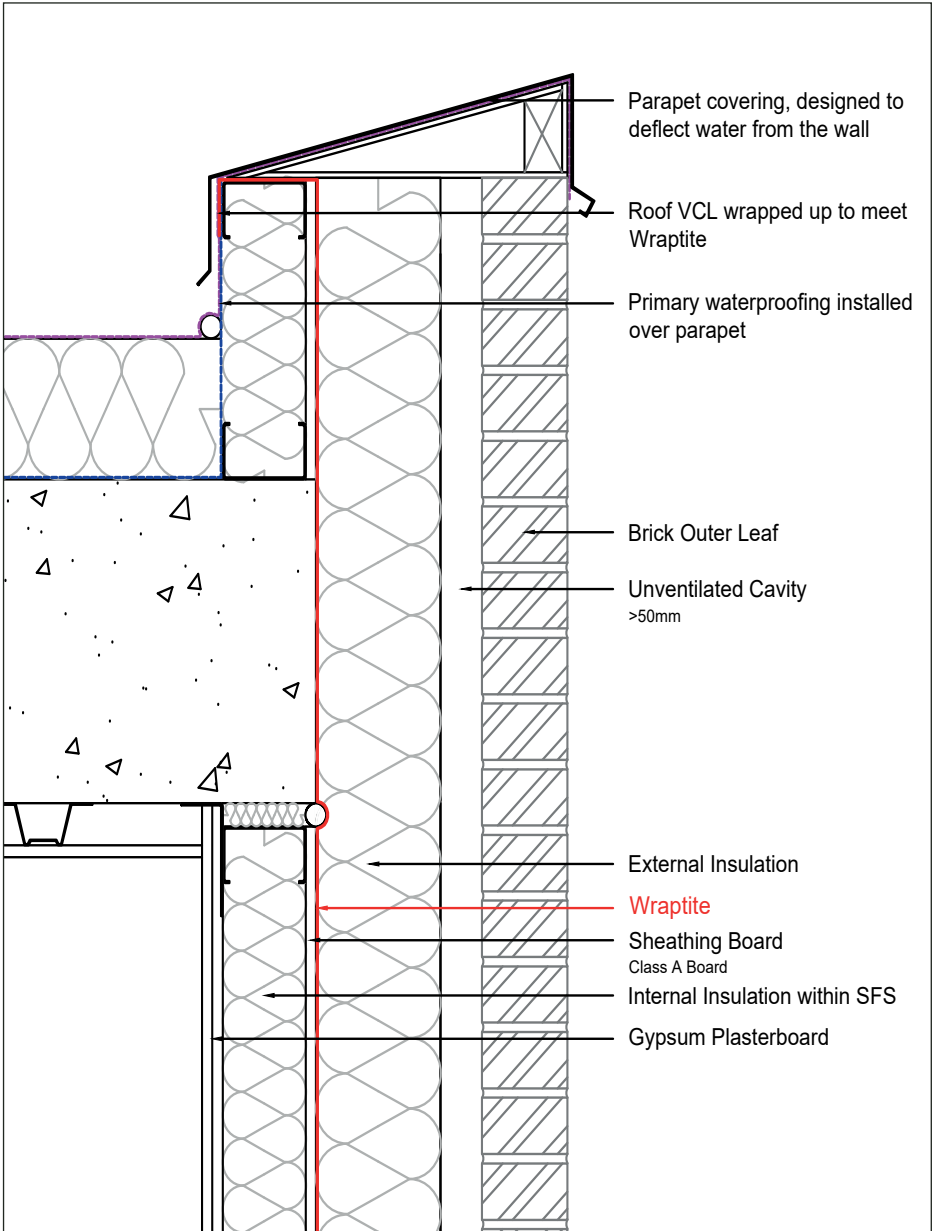

PARAPET W. BRICK FAÇADE

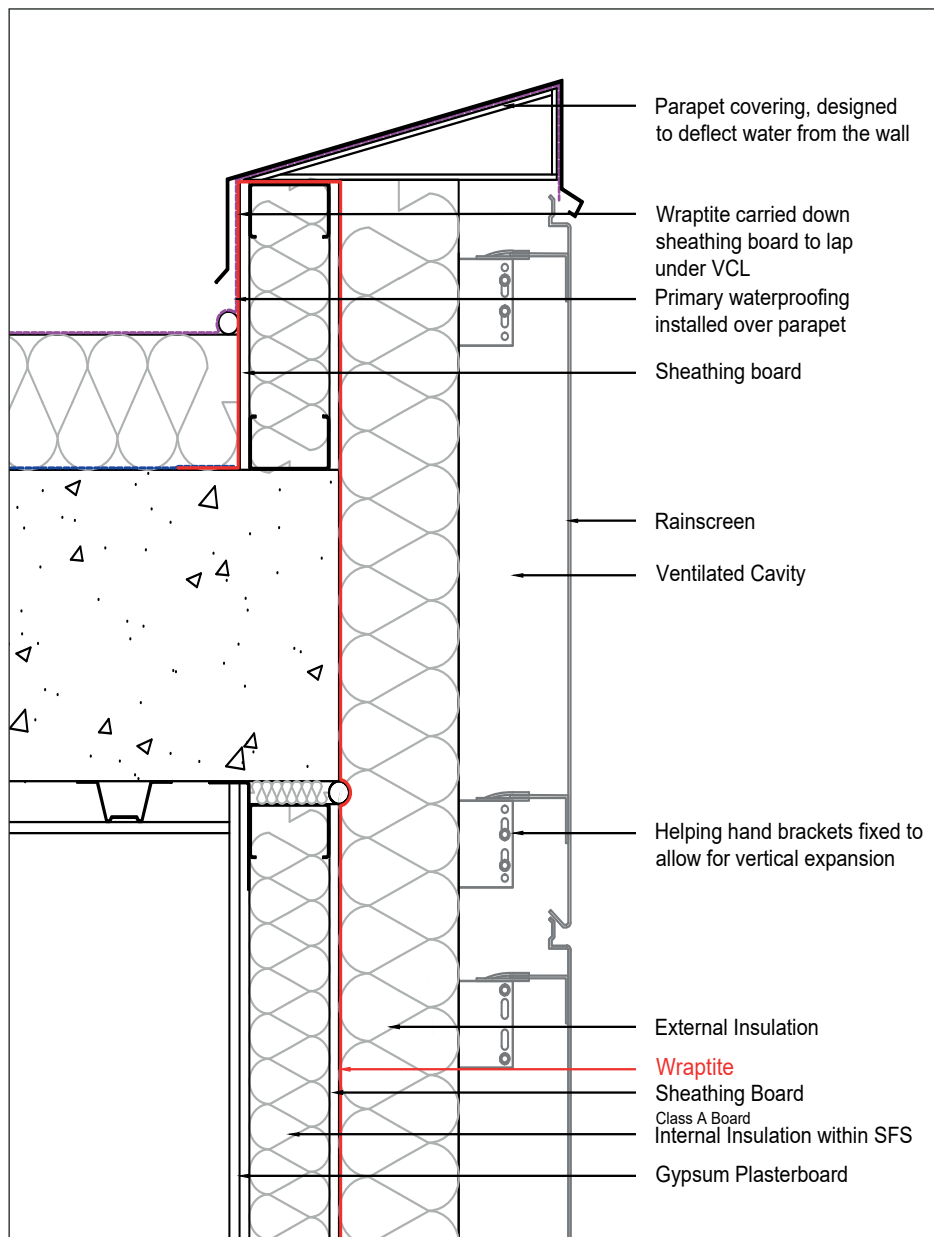

PARAPET W. RAINSCREEN

17.a DETAIL: BALCONY, STEEL

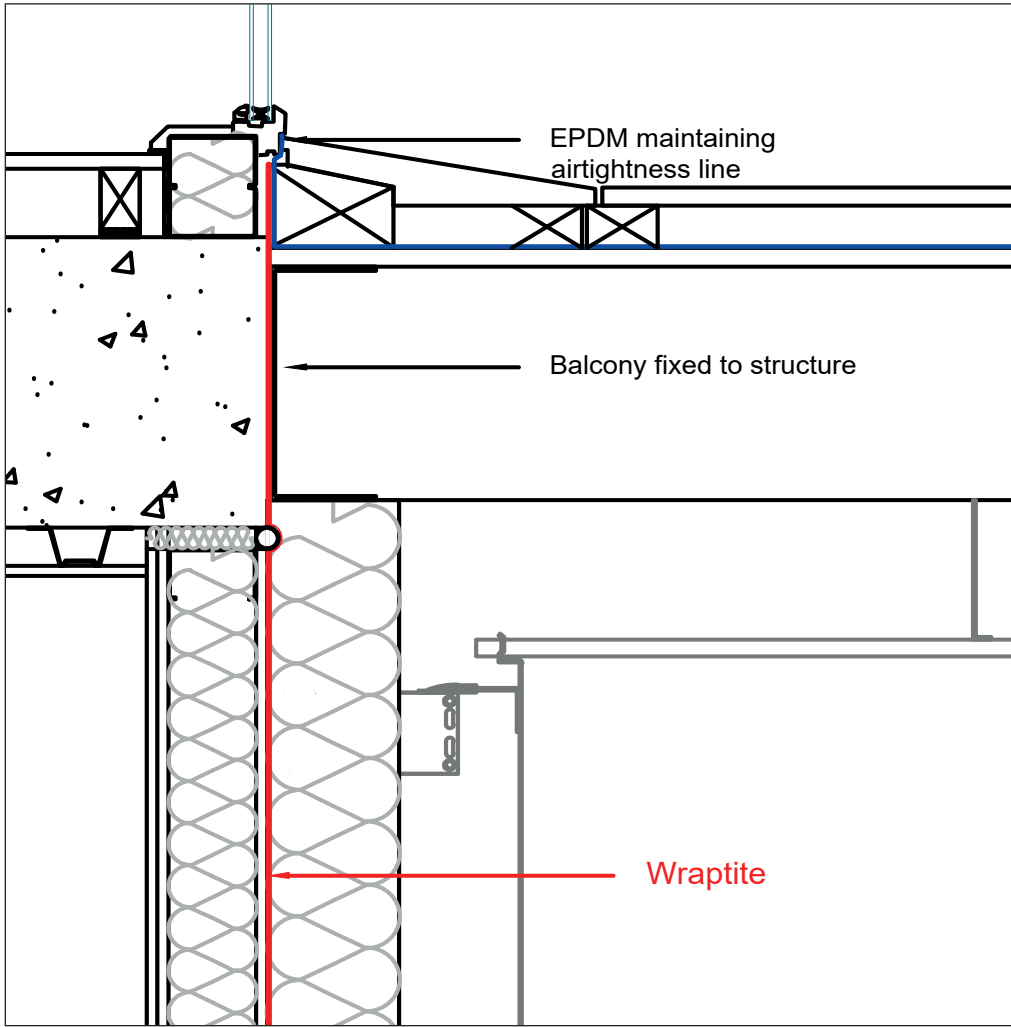

STEEL BALCONY, RAINSCREEN CLADDING

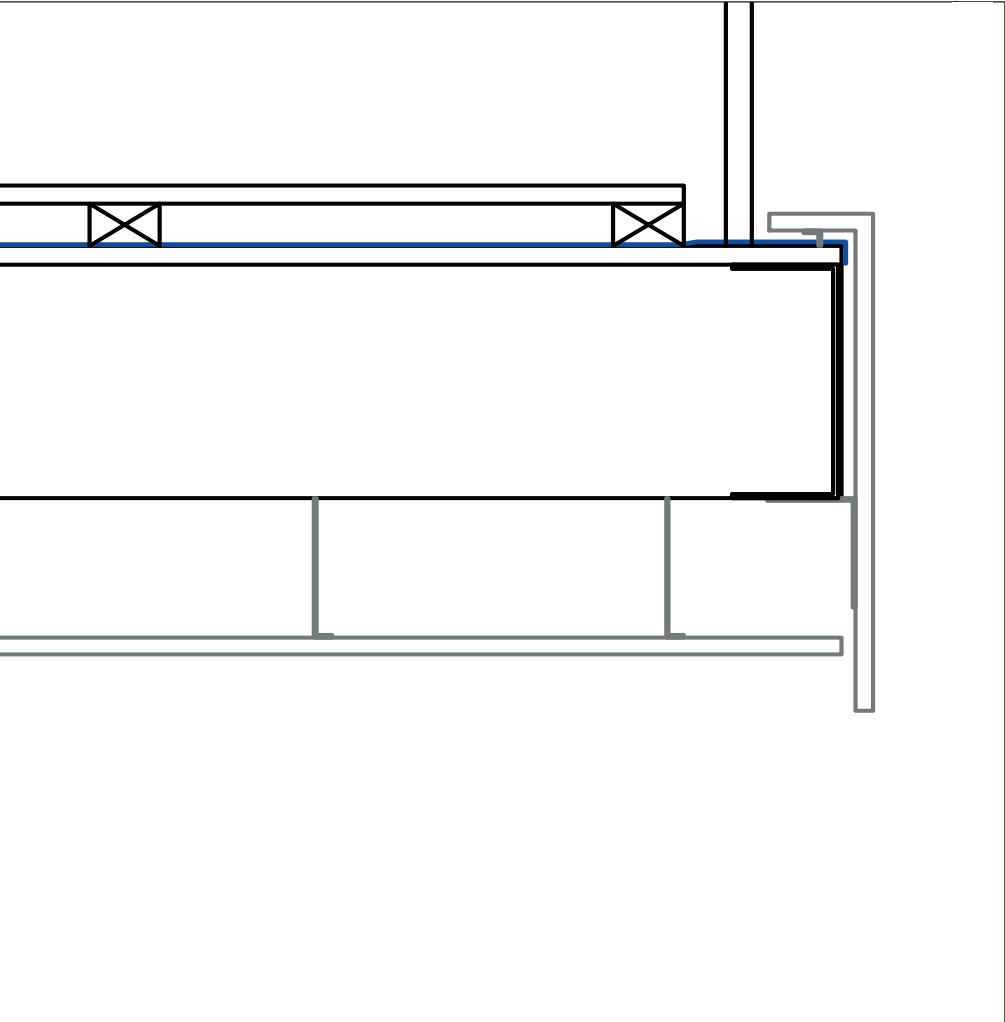

17.b DETAIL: BALCONY, CONCRETE

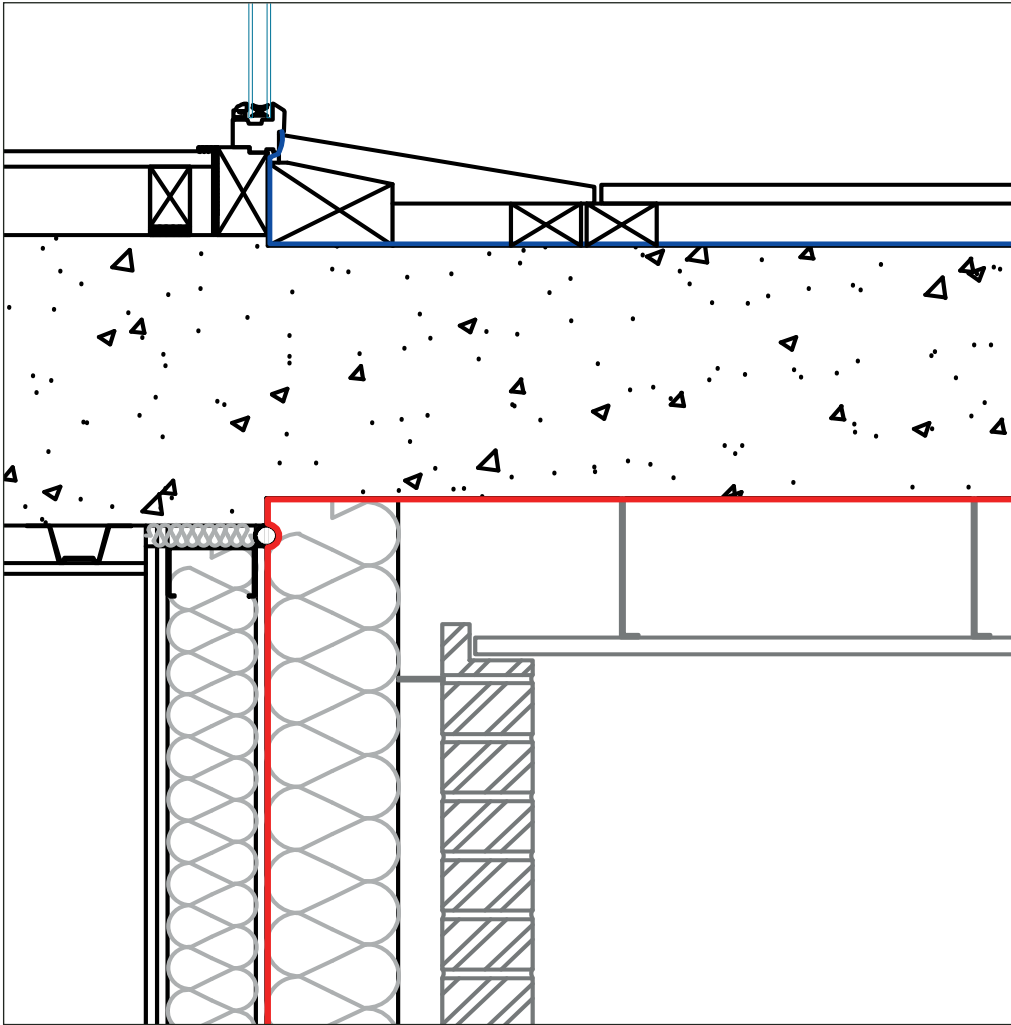

CONCRETE BALCONY, BRICK FAÇADE

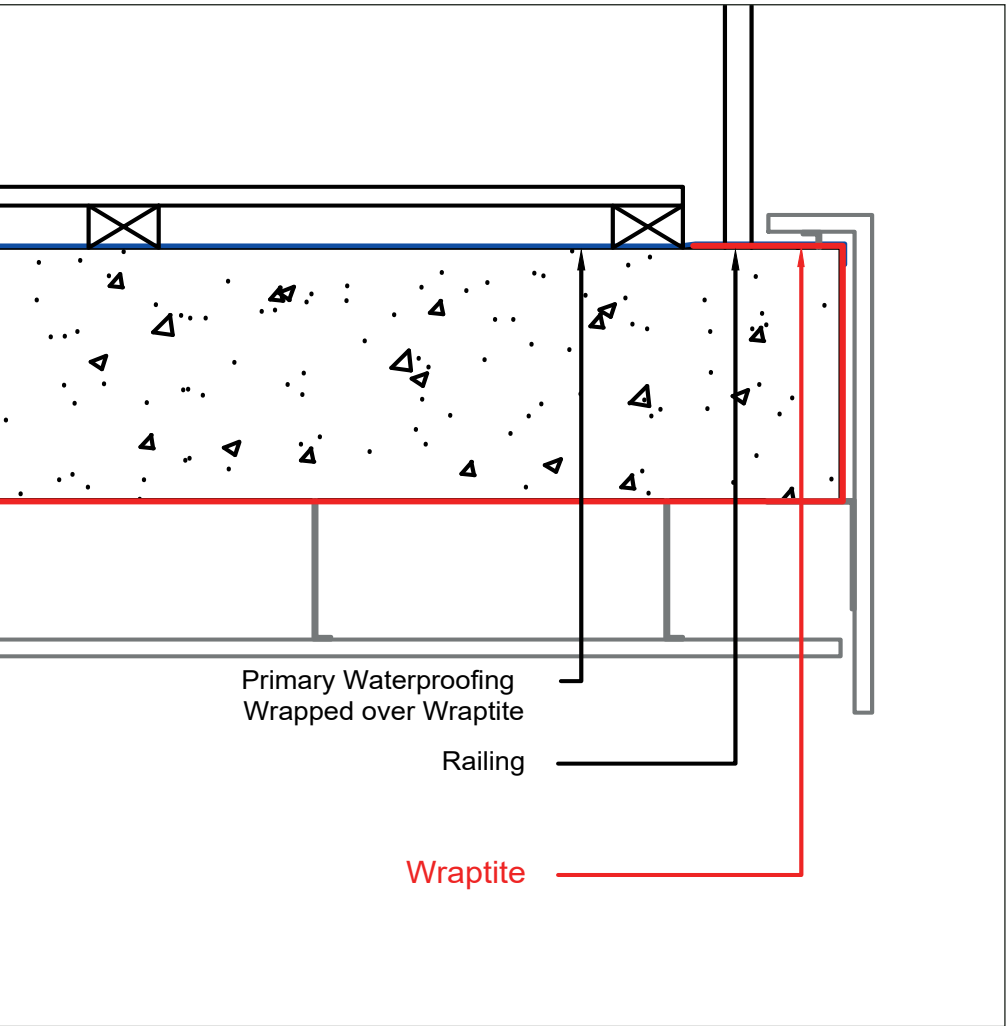

18. COMPLIANCE & TROUBLESHOOTING

Expansion Joint

Example of good detailing around the Expansion Joint. (image right)
Installed in a straight line with sufficient deflection to allow Membrane to move.



Notes: _____

Exposed Substrate

Large tears and awkward wall penetrations can result in the substrate being left exposed. Seal substrate using Wraptite Tape with a minimum 75mm overlap &/or Liquid Flashing.



18. COMPLIANCE & TROUBLESHOOTING

Creases & Bubbles

Wraptite Membrane should be rolled out and pressed flat to the substrate as much as possible to avoid creating air pockets and bubbles. Some creases are unavoidable.

Notes: _____



Small Punctures & Tears

Fixings that are flush or penetrate through the Membrane should be treated with minimum 75mm wide Wraptite Tape. Small tears should be similarly repaired.

Notes: _____

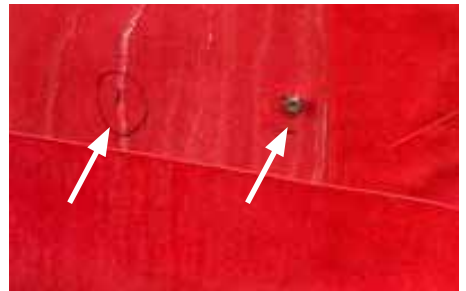

Reverse Shingle

In areas where a reverse shingle effect has occurred, treat either with Wraptite Tape ensuring the overlap onto the surface is a minimum of 75mm, or apply a generous bead of Wraptite Liquid Flashing to the leading edges of the Membrane and smooth over.

Notes: _____

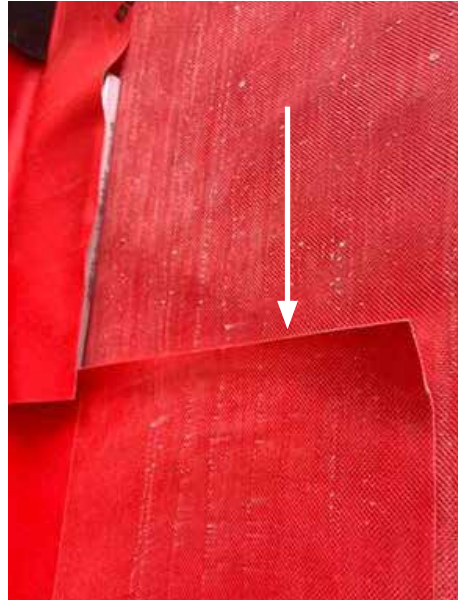

Peel-back & Delamination

Remediate areas of peel-back with Wraptite Tape ensuring a 75mm overlap. If the membrane has lost its adhesion strength, remove the material completely and replace.

Notes: _____



18. COMPLIANCE & TROUBLESHOOTING

Incomplete Detailing

Areas around window bottoms must be fully lapped under with the Membrane. Remove any excess material.

Notes: _____

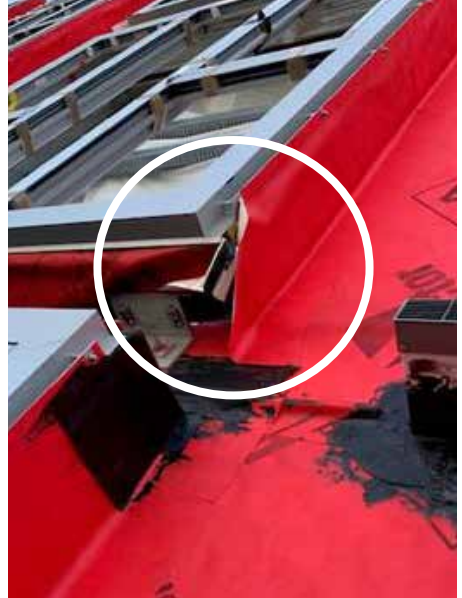

Incomplete Detailing

Trim Membrane around brackets and other wall penetrations as close to the edges of the item as possible. Seal exposed edges as per recommended guidelines using Tape or Liquid Flashing.

Notes: _____

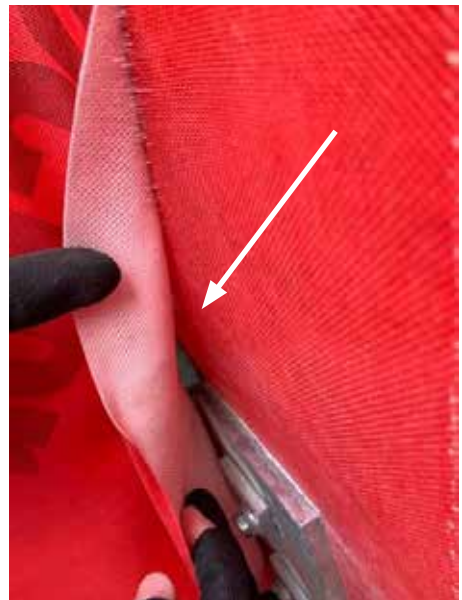

Incomplete Detailing

Overlap around the window is not complete. Requires trimming and the addition of Tape &/or Liquid Flashing to complete the seal.

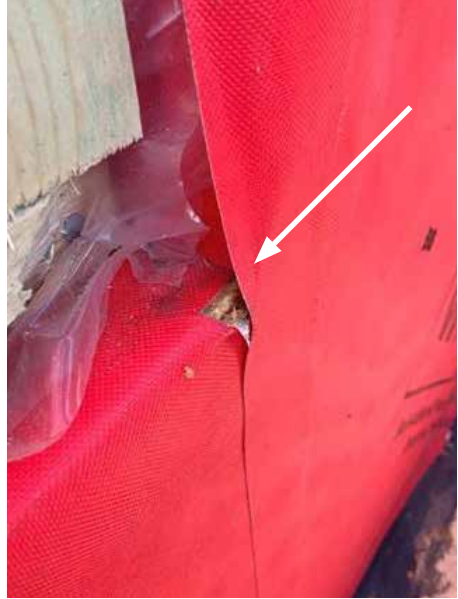

Notes: _____

Incomplete Detailing

Use Liquid Flashing to seal weak points in airtightness including door and window corners and the edges of major wall penetrations as described in the Installation Guidelines.

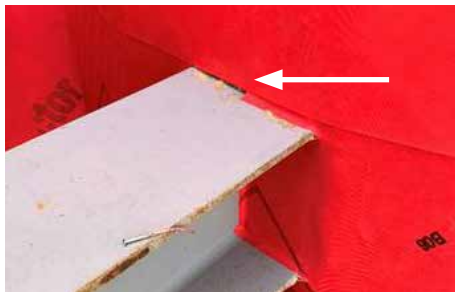

Notes: _____

18. COMPLIANCE & TROUBLESHOOTING

Insufficient / Incomplete Overlaps

Membrane overlaps must be min. 75mm and form a complete seal. Reposition Membrane to provide 75mm overlap - Membrane may need to be replaced if adhesion is lost. Alternatively use Wraptite Tape over Membrane edge to provide the recommended overlap.

Notes: _____

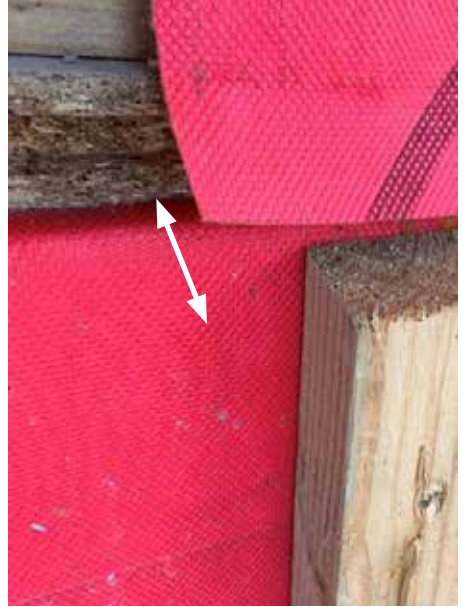

Onsite Damage

Onsite damage and contamination can negatively affect long-term performance of Wraptite (e.g. concrete splash). Clean contamination immediately &/or replace Membrane.



Notes: _____

Compromised Adhesive Backing

This window opening was left covered with Wraptite with the protective lining paper removed. The Membrane's adhesive backing was compromised due to dust migration and required Wraptite Tape to lap it back into the window opening.



Notes: _____





“I believe the success of the A.Proctor Group is down to a solid foundation of innovation backed up by an excellent, loyal and committed team, every one of them playing an important role in our continued success. Scotland provides us with a unique platform to launch our ideas, systems and products. I am fiercely proud of this heritage and our brand.”

Keira Proctor
Managing Director, A. Proctor Group Ltd

The contents of this literature are provided by A. Proctor Group Limited (APG) in good faith and considered to be factual and accurate at the date of publication. These do not constitute specific technical recommendations and are provided for general information purposes only. It is for the engineer, architect or other relevant professional engaged to advise on any project to assess and satisfy themselves on the suitability of APG products for their intended use on that project. Please note that information contained in this literature may be subject to change with advances in usability and experience.

www.proctorgroup.com | +44 (0) 1250 872261
contact@proctorgroup.com

